



LABmaster sp / dp WORKSTATION

PICTURE SHOWS PRODUCT WITH OPTIONS



- Ready to operate workstation, incl. main antechamber and vacuum pump
- Different glovebox sizes available
- PLC controlled with Siemens color touch panel
- Automatic regenerable H₂O/O₂ purifier (single (sp) / double (dp))
- Attainable purity <1 ppm H₂O, <1 ppm O₂
- Stainless steel encapsulated blower MB-BL-01 with frequency converter
- Circulation capacity more than 84 m³/h (50 cfm) at ΔP = 60 mbar (60 Hz)
- World-wide operation using standard power supply
- Integrated high vacuum feedthroughs
- Conform to CE



LABmaster sp / dp

Technical Data

General Data

Product: Inert gas system **Labmaster**
Type: Modular glovebox with gas purification system
Size: Various sizes available, see page 5

System Control

Control unit: Programmable logic controller (PLC)
Operation: 5.7" full color touch panel with simulated multi-language operation elements for all glovebox components, foot pedal for box pressure adjustment
Electrical power: 230 V/50-60 Hz, 10 A or 115 V / 50-60 Hz, 20 A or 100 V/ 50-60 Hz, 20 A (power consumption may vary dependent on accessories)

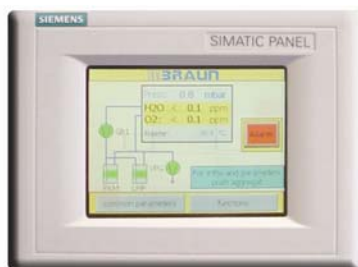

Touch Panel TP177B color

Gas Purification

Process

Gas circulation: Closed loop gas recirculation

Gas Purification System

Removal of H₂O and O₂

Working Gas

Inert gas: Nitrogen, Argon or Helium

Attainable Purity

H₂O < 1 ppm, O₂ < 1 ppm

Purifier

Amount / type: 1 H₂O / O₂ purifier column
Capacity: Oxygen removal: 30l (standard conditions), Moisture removal: 1700 g
Material: Stainless steel type 1.4301 (US type 304)
Heater: Integrated

Gas Purification

Regeneration

The purifier unit is regenerable
Procedure: Autom. regen. program (PLC controlled)
Regeneration gas: N₂/H₂ mixture (H₂ 3-5 %) or Ar/H₂ mix. (H₂ 3-5 %)

Cooling

Type: Water cooling 2-3 l/min* (water pressure 200-300 kPa) (in case of excess heat generation inside glovebox additional box integrated heat exchangers are available)
*Chiller ULK 1000 on request

Circulation Unit

Type: Integrated blower **MB-BL-01** vacuum-tight, oil-free
Flow rate: 84 m³/h (50 cfm) at ΔP = 60 mbar (60 Hz)
Features: Operated with all standard power supplies; optimum system tuning by frequency preselection for the blower

Vacuum Pump

Type: Rotary vane pump*, oil mist filter, oil recirculation, automatic gas ballast control
Operation: 12 m³/h (10,9 cfm/m at 60Hz), dual stage, ultimate vacuum < 3 x 10⁻² hPa
*Dry pump on request

Valves

Main valves: Electro-pneum. valves **MB EPV-40** DN 40
Control valves: **MB LogicSVB** magnetic valve system, DN 4/6

Piping

Main piping: Copper pipe DN 40 KF system*
Control pipework: Copper pipe DN 4/8*
*Stainless Steel pipe 1.4301 (US type 304) on request

Integral Leak Rate

Less than 10⁻⁵ mbar l/s

LABmaster sp / dp

Purifier Performance

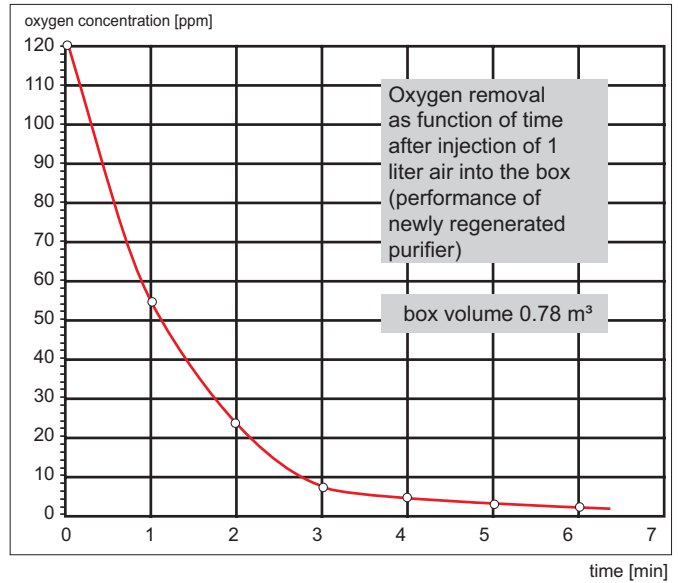
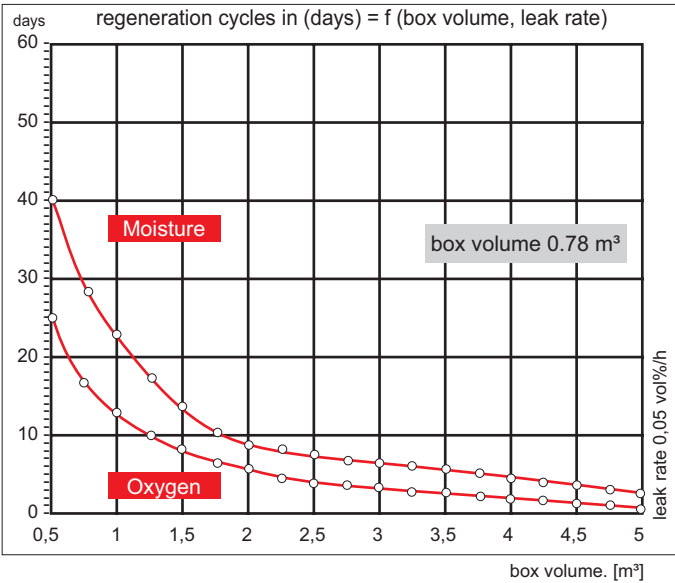

Glovebox

Type

Glovebox with bolted side panels

Material: Stainless Steel 1.4301 (US type 304), thickness 3 mm

Inside surface: Brushed finish $R_a < 1 \mu\text{m}$ (DIN ISO 1302)

Outside surface: Coated, grey (RAL 7035)

Glovebox inside dimensions: length: 1250 mm/1500 mm/1800mm, height: 900 mm, depth: 780/1000/1200 mm

Feedthroughs

DN 40 KF: 4 pieces for customers usage (e.g. electrical feedthrough)

Electrical feedthrough: KF40 included (100, 110 or 230 V)

Dust Filter

MB-BF-L-03[®] 0.3 μm , class H 13, 1 gas inlet filter / 1 gas outlet filter

Shelves

3 shelves: Stainless steel 1.4301 (US type 304), height adjustable, for 780mm depth glovebox

2 shelves: Stainless steel 1.4301 (US type 304), hanging from box ceiling, for 1000/1200mm depth gloveboxes

Glovebox

Box Windows

Inclined panel: Lexan thickness 10 mm*

*safety glass on request

Glove Ports

Type: POM (Polyoxymethylen) 220 mm dia., O-ring sealed

Gloves

Material: Butyl, thickness 0.4 mm*

*other sizes and materials on request

Box Light

Fluorescent lamp: Front mounted

Leak Rate According to ISO 10648-2 (Oxygen Method)

< 0.05 vol%/h typical (Class 1, measured at final acceptance test)

Leak Rate According to ISO 25412 (Press. Change Method)

< 0.05 vol%/h at negative pressure of 10 mbar at constant temp. (measured at final acceptance test)

LABmaster sp / dp

Main Antechamber

Type

Cylindric type antechamber* 390 mm diameter, length 600 mm (inside dimensions)

Material: Stainless Steel 1.4301 (US type 304), thickness 2.5 mm

Inside surface: Brushed finish

Outside surface: Coated, grey (RAL 7035)

*rectangular on request

Sliding Tray

Material: Stainless Steel 1.4301 (US type 304)

Doors

Material: Aluminum (AlMg3), anodized, thickness 10 mm

Door lock: Easy to operate spindle-lock with lifting mechanism

Pressure Gauge

Manometer: Analog display

Optional: Pirani gauge (when using automatic antechamber control)

Vacuum / Refill Process

Handling: Push button evacuation and refill from operation panel (Semi-automatic antechamber control)

Optional feature: Fully-automatic antechamber control with programmable evacuation/refill cycles and automatic leak test

Main Antechamber Operation

Valves

MB EPV-40: Electro-pneumatic valve DN 40, evacuation line PLC-controlled, solenoid valve DN 4 refill line PLC-controlled

Leak Rate

$<10^{-5}$ mbar l/s

Basic System Configuration

- Glovebox with stand, incl. castors + leveling feet
- Main antechamber
- Gas purification system with vacuum pump RV12
- Shelves
- One piece electrical feedthrough

Optional Features

The system can be extended with the following optional components:

- Mini antechamber
- Rectangular antechamber
- H₂O/O₂-analyzer
- Refrigerator
- Solvent absorber
- Microscope equipment
- Automatic antechamber control
- Mechanical door locks
- Auto purge function
- Stainless steel piping
- Solvent purification systems

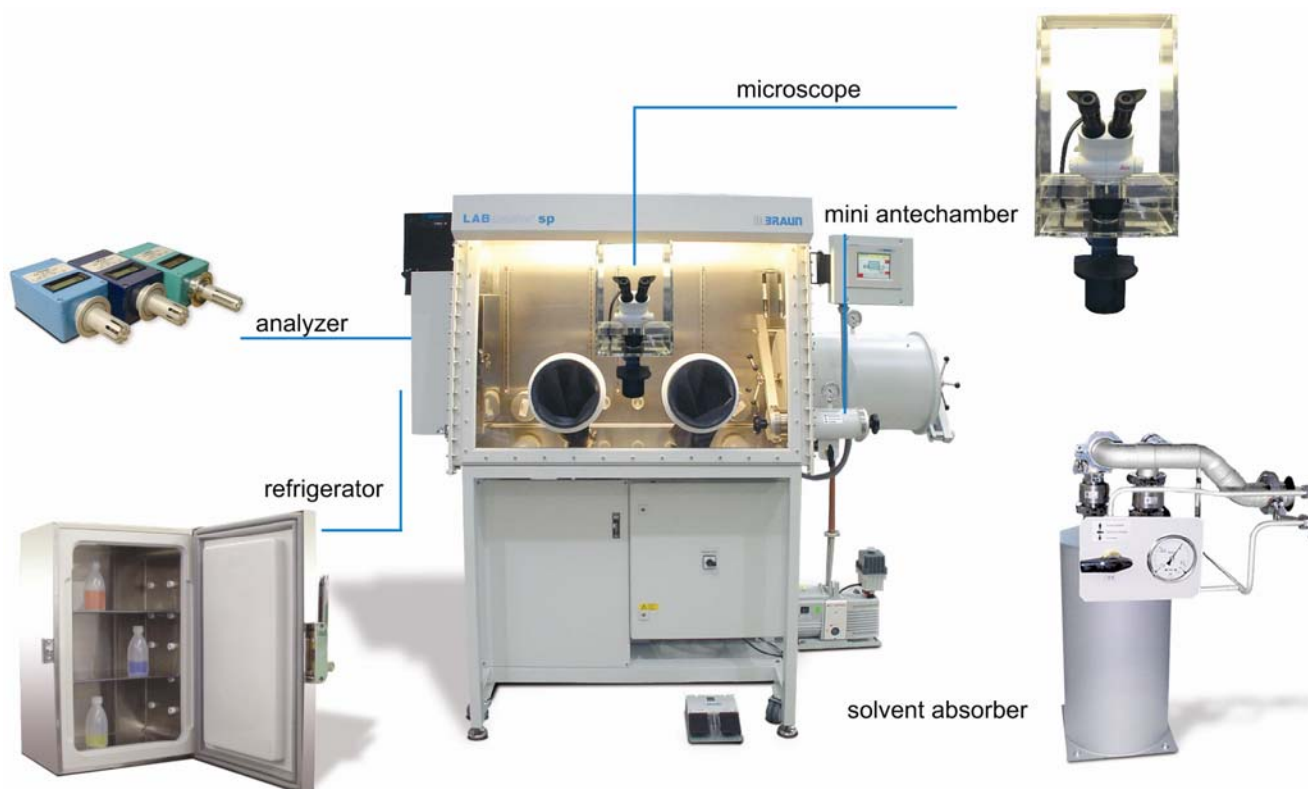

LABmaster sp / dp

Dimension

The **LABMASTER** system is available in the following box sizes and depths: outer dimensions (mm)

Weight 400 kg

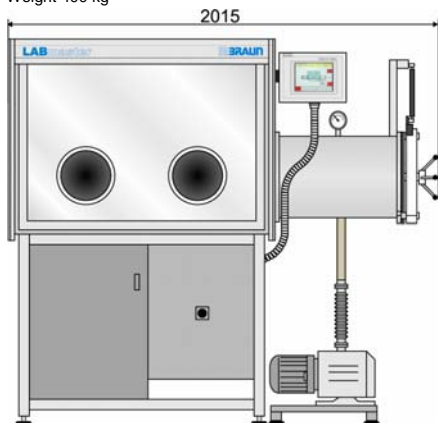

Weight: 450 kg

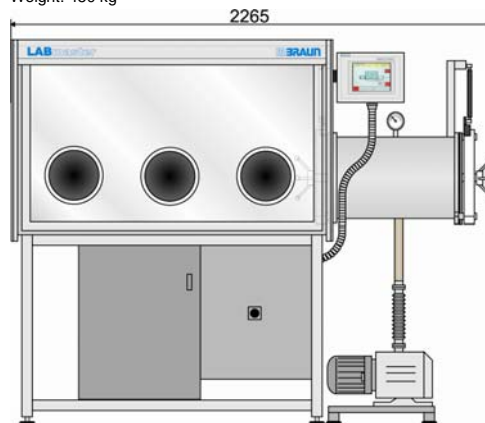

Weight 600 kg

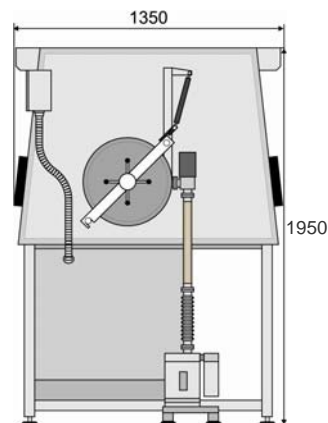
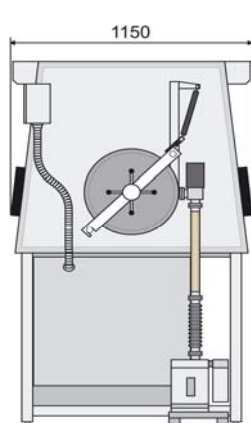
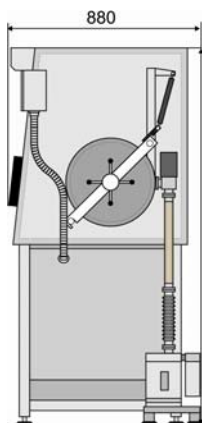
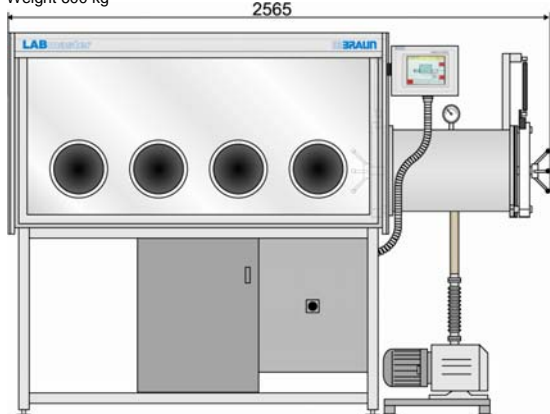

Utilities

Designation	Medium	Pressure (kPa)	Temp. (°C)	Flowrate (l/min)	Connection Ø
Cooling water inlet, opt. use	Water	300	max. 20	2 - 3	8 mm hose ID
Cooling water outlet		50	max. 32		8 mm hose ID
Working gas	N ₂ or Ar 4.8	600		250	Swagelok 10 mm
Regeneration gas	Ar/H ₂ 95/5	30 - 50		20 - 25	Swagelok 10 mm
Regeneration gas exhaust	or N ₂ /H ₂ 95/5				Swagelok 10 mm

LABmaster sp / dp

Box Volume Table

Box height 900 mm

Box length 1250 mm

Box length 1500 mm

Box length 1800 mm

Box depth 780 mm

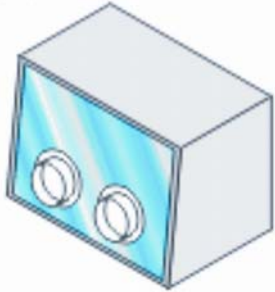

approx. 0.8 m³

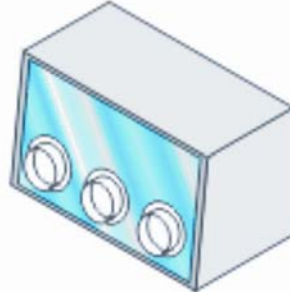

approx. 1.0 m³

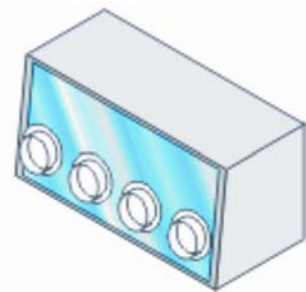

approx. 1.2 m³

Box depth 1000 mm

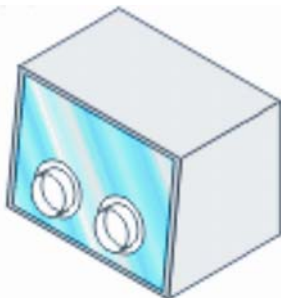

approx. 1.0 m³

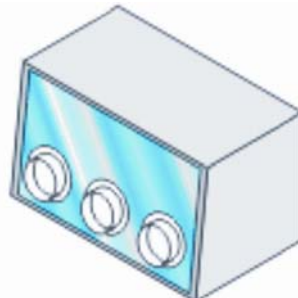

approx. 1.2 m³

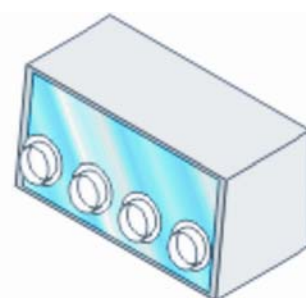

approx. 1.5 m³

Box depth 1200 mm

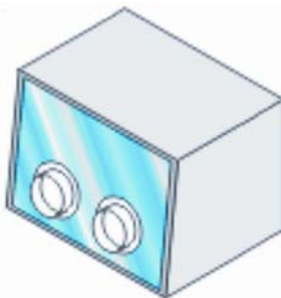

approx. 1.2 m³

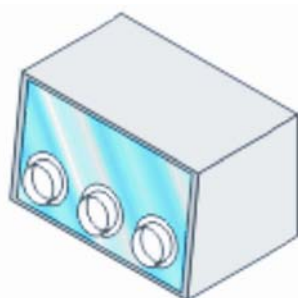

approx. 1.5 m³

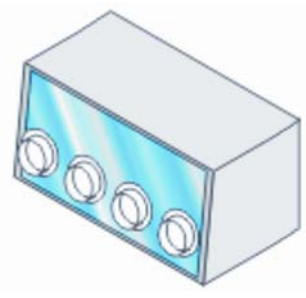

approx. 1.8 m³



M. Braun Inertgas-Systeme GmbH Head-Office Germany • Dieselstr. 31, D-85748 Garching • Phone: +49(0) 89-3 26 69-0

Fax: +49(0) 89-3 26 69-105 • E-Mail: info@mbraun.de

M. Braun Inc. USA • 14 Marin Way, Stratham, NH 03885 • Phone: +1-603-773-9333 • Fax: +1-603-773-0008 • E-Mail: info@mbraunusa.com

M. Braun Inertgas Systems (Shanghai) Co., Ltd. China • 828 Xin Jinqiao Road • Pudong Shanghai 201206, P.R.C.

Phone: +86-21-50320257 • Fax +86-21-50320229 • E-Mail: info@mbraunchina.com

M. Braun Service Japan • Yoshikawa building, 3rd floor • 6-32 Honcho, Wako-shi • Saitama 351-0114 • Phone: +81-48-452-6367 • Fax: +81-48-452-6368

Internet www.mbraun.de • www.mbraunusa.com • www.mbraunchina.com